

建設機械（特にミニショベル）、工作機械・特装車等において、機械の効率化・高機能化により油圧機器や配管スペースのコンパクト化が進んでおり、狭いスペースでも取付容易なスリムで柔軟な高圧ホースが求められています。これらの市場ニーズに応えるために開発されたホースです。

究極の三位一体化技術

新規開発極細ワイヤーの採用と、チューブ・補強層・カバーの三位一体化技術の追求により、超柔軟化に成功しました。
狭い配管・曲げ半径が極小な配管が可能になりました。

押出技術の追求

内面ゴム・外面ゴムを極限まで薄くしております。

ハイテンションなワイヤーを開発・採用することにより、補強ワイヤを極端に細くしております。

SIBシリーズ

SIB15

構造

内面ゴム: 耐油性合成ゴム
補強層: 繊維
外面ゴム: 耐油・耐候性合成ゴム

適用流体

一般鉱物系作動油

温度範囲

-40℃~+100℃

ホース構造・補強層

1T/B



サイズ	補強層	内径 mm	外径 mm	最高使用圧力 MPa(kgf/cm ²)	最小破壊圧力 MPa(kgf/cm ²)	最小曲げ半径 mm	重量 g/m
6	1T/B	6.3	11.5	1.5(15)	6.0(60)	45	100
9	1T/B	9.5	15.2	1.5(15)	6.0(60)	60	150
12	1T/B	12.7	18.5	1.5(15)	6.0(60)	80	200

サイズ	B	C	D	H	L	R(PT)	使用 Oリング	重量g
6	14	6	4.2	17	50	1/4	P-6	30
9	14	6	6.5	19	53	3/8	P-9	45
12	18	8	9.5	22	63	1/2	P-12	84

PART NO. SW1

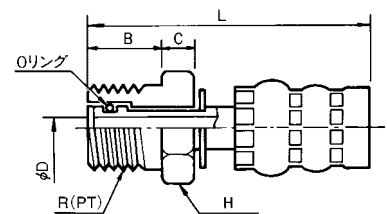

管用テーパおねじ
(簡易スイベルタイプ)

サイズ	B	C	D	H	L	G(PF)	使用Oリング		重量g
							1	2	
6	10.5	8	4.2	19	49	1/4	P-6	P-11	34
9	10.7	8	6.5	22	52	3/8	P-9	P-14	50
12	14.5	10	9.5	27	62	1/2	P-12	P-18	95

PART NO. SW2

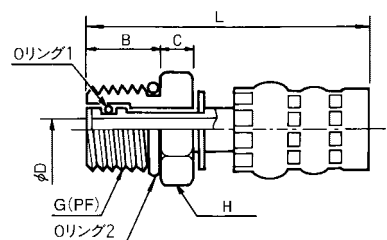

管用平行おねじ
(簡易スイベルタイプ)

SIBシリーズ

SIB15

サイズ	B	C	D	H	L	R (PT)	重量g
6	13	6	4.2	17	44	1/4	30
9	15	6	7.0	19	49	3/8	49
12	18	8	9.5	22	58	1/2	81

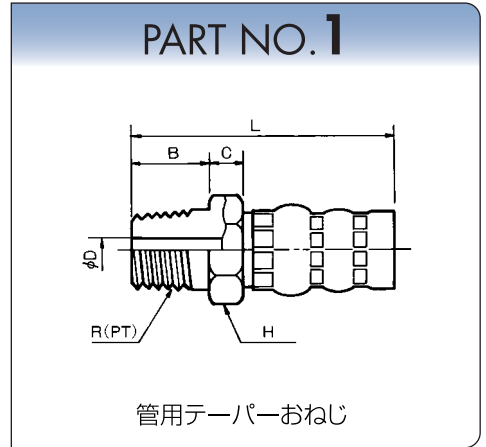

サイズ	A	B	C	D	E	H	H1	L	G (PF)	重量g
6	8.5	16.0	6	4.2	9.5	19	17	47	1/4	42
9	9.5	19.0	6	7.0	13.0	22	19	53	3/8	61
12	11.0	21.5	8	9.5	16.0	27	22	62	1/2	98

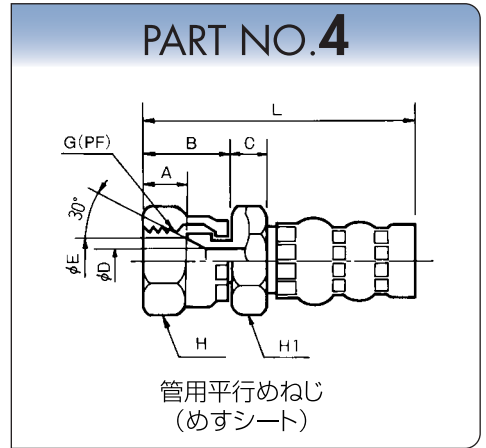

サイズ	A	B	C	D	E	H	H1	L	G (PF)	重量g
6	4.5	16.0	6	4.2	7.0	19	17	47	1/4	44
9	5.5	19.0	6	7.0	9.7	22	19	53	3/8	66
12	7.5	21.5	8	9.5	13.0	27	22	62	1/2	104

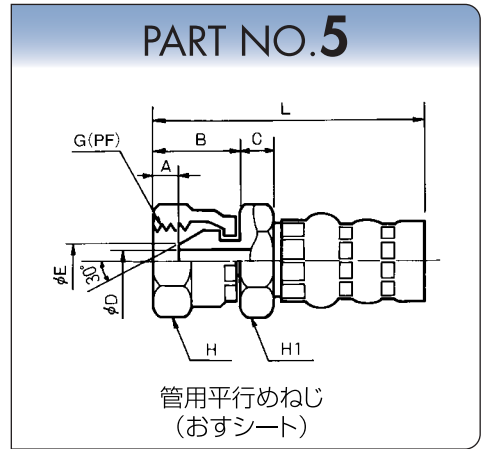

サイズ	A	B	C	D	E	H	H1	L	UNF	重量g
6	8.5	16.0	6	4.2	7.5	19	17	47	7/16-20	44
9	9.5	19.0	6	7.0	11.0	22	19	53	9/16-18	62
12	11.0	21.5	8	9.5	14.5	27	22	62	3/4-16	105

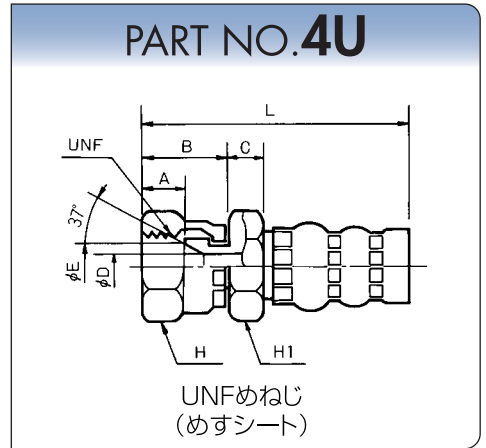

SIBシリーズ

SIB15

サイズ	A	D	E	F	H	J	L	G(PF)	重量g
6	8.5	4.2	9.5	34	19	26	49	1/4	45
9	9.5	6.5	13.0	47	22	34	60	3/8	79
12	10.5	9.5	16.0	54	27	39	69	1/2	114

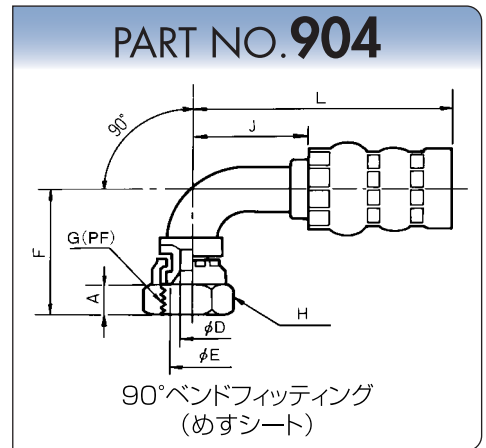

サイズ	A	D	E	F	H	J	L	G(PF)	重量g
6	4.5	4.2	7.0	31.5	19	26	49	1/4	45
9	5.5	6.5	9.7	40	22	34	60	3/8	79
12	7.0	9.5	13.0	55	27	37	67	1/2	114

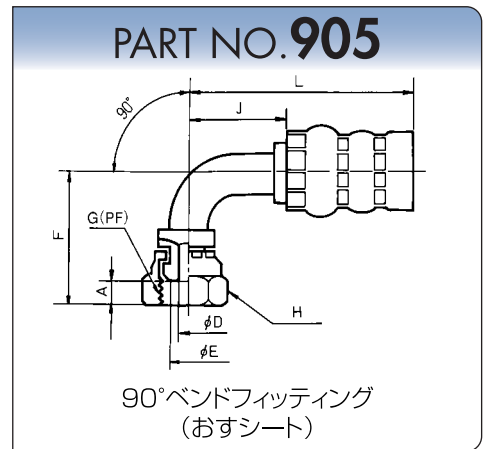

サイズ	A	D	E	F	H	J	L	G(PF)	重量g
6	8.5	4.2	9.5	24	19	44	67	1/4	40
9	9.5	6.5	13.0	26	22	49.5	76	3/8	72
12	10.5	9.5	16.0	29.6	27	55.5	85	1/2	110

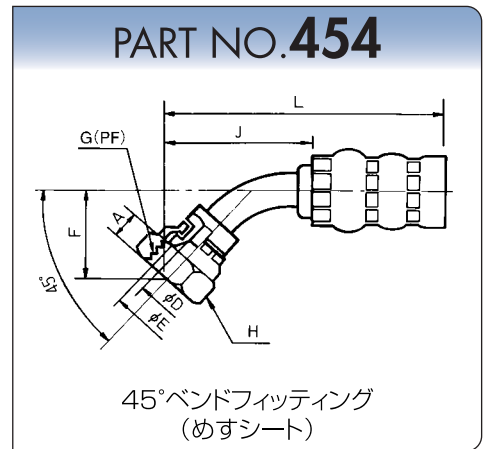

サイズ	A	D	E	F	H	J	L	G(PF)	重量g
6	4.5	4.2	7.0	16.5	19	34.5	58	1/4	40
9	5.5	6.5	9.7	20.9	22	44.5	71	3/8	72
12	7.0	9.5	13.0	31.2	27	55.5	85	1/2	110

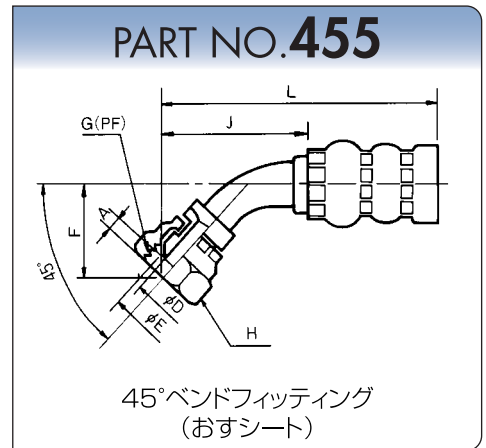

SIBシリーズ

SIB15

サイズ	B	C	D	F	H	J	L	R (PT)	使用 Oリング	重量g
6	14	6	4.2	39	17	23	46	1/4	P-6	36
9	14	6	6.5	45	19	34	60	3/8	P-9	62
12	18	8	9.5	58	22	47	77	1/2	P-12	108

PART NO. SW901

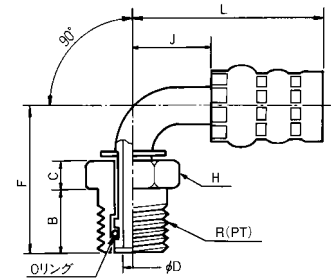

90°バンドフィッティング
(おねじ簡易スィベルタイプ)

サイズ	B	C	D	F	H	J	L	G (PF)	使用Oリング		重量g
									1	2	
6	10.5	8	4.2	37.5	19	23	46	1/4	P-6	P-11	40
9	10.7	8	6.5	43.5	22	34	60	3/8	P-9	P-14	65
12	14.5	10	9.5	57	27	47	77	1/2	P-12	P-18	119

PART NO. SW902

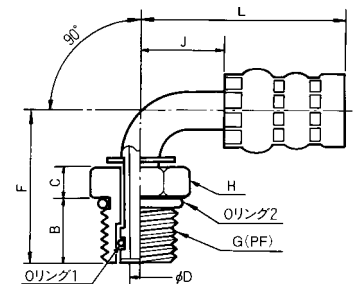

90°バンドフィッティング
(平行ねじ簡易スィベルタイプ)

サイズ	B	C	D	F	H	J	L	R (PT)	使用 Oリング	重量g
6	14	6	4.2	22.6	17	38.6	62	1/4	P-6	33
9	14	6	6.5	24.3	19	47.8	74	3/8	P-9	57
12	18	8	9.5	30.7	22	63.1	93	1/2	P-12	100

PART NO. SW451

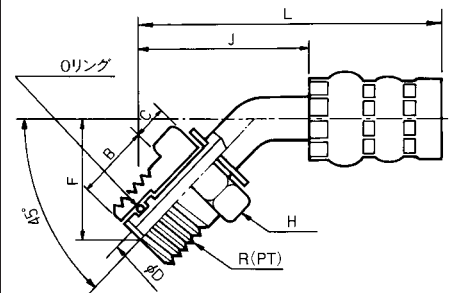

45°バンドフィッティング
(おねじ簡易スィベルタイプ)

サイズ	B	C	D	F	H	J	L	G (PF)	使用Oリング		重量g
									1	2	
6	10.5	8	4.2	21.6	19	37.6	61	1/4	P-6	P-11	37
9	10.7	8	6.5	23.3	22	46.8	73	3/8	P-9	P-14	62
12	14.5	10	9.5	29.6	27	62.0	92	1/2	P-12	P-18	111

PART NO. SW452

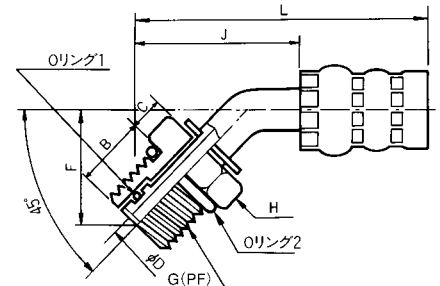

45°バンドフィッティング
(平行ねじ簡易スィベルタイプ)

SIBシリーズ

SIB35

構造

内面ゴム: 耐油性合成ゴム
 補強層: 繊維
 外面ゴム: 耐油・耐候性合成ゴム

適用流体

一般鉱物系作動油

温度範囲

-40℃~+100℃

ホース構造・補強層

1T/B



サイズ	補強層	内径 mm	外径 mm	最高使用圧力 MPa(kgf/cm ²)	最小破壊圧力 MPa(kgf/cm ²)	最小曲げ半径 mm	重量 g/m
6	1T/B	6.3	11.5	3.5(35)	14.0(140)	45	100
9	1T/B	9.5	15.2	3.5(35)	14.0(140)	60	150
12	1T/B	12.7	18.5	3.5(35)	14.0(140)	80	200
19	1T/B	19.0	27.1	3.5(35)	14.0(140)	130	355
25	1T/B	25.4	33.9	3.5(35)	14.0(140)	165	515

サイズ	B	C	D	H	L		R(PT)	使用 Oリング	重量g
6	14	6	4.2	17	50		1/4	P-6	30
9	14	6	6.5	19	53		3/8	P-9	45
12	18	8	9.5	22	63		1/2	P-12	84

PART NO. SW1

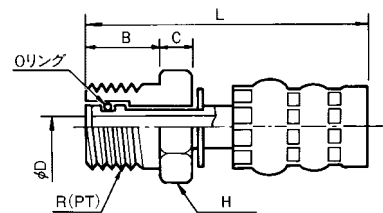

管用テーパードネジ
(簡易スイベルタイプ)

サイズ	B	C	D	H	L	G(PF)	使用Oリング		重量g
							1	2	
6	10.5	8	4.2	19	49	1/4	P-6	P-11	34
9	10.7	8	6.5	22	52	3/8	P-9	P-14	50
12	14.5	10	9.5	27	62	1/2	P-12	P-18	95

PART NO. SW2

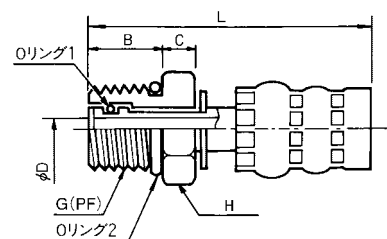

管用平行ドネジ
(簡易スイベルタイプ)

SIBシリーズ

SIB35

サイズ	B	C	D	H	L		R (PT)	重量g
6	13	6	4.2	17	44		1/4	30
9	15	6	7.0	19	49		3/8	49
12	18	8	9.5	22	58		1/2	81
19	20	10	16.0	36	69		3/4	221
25	22	10	21.8	41	76		1	300

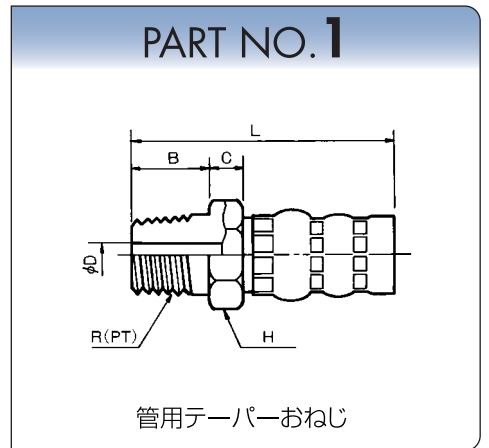

サイズ	A	B	C	D	E	H	H1	L	G (PF)	重量g
6	8.5	16.0	6	4.2	9.5	19	17	47	1/4	42
9	9.5	19.0	6	7.0	13.0	22	19	53	3/8	61
12	11.0	21.5	8	9.5	16.0	27	22	62	1/2	98
19	12.5	23.0	10	16.0	22.0	36	36	72	3/4	266
25	12.5	25.5	10	21.8	28.0	41	41	79	1	300

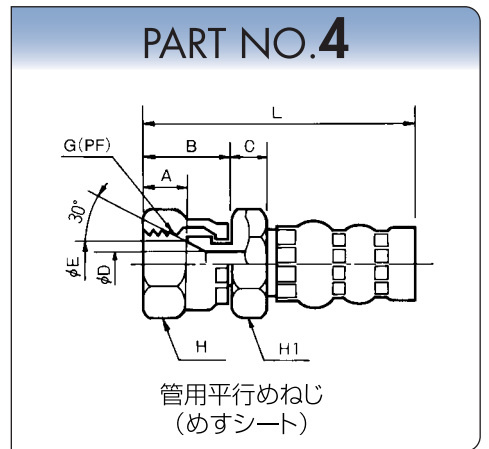

サイズ	A	B	C	D	E	H	H1	L	G (PF)	重量g
6	4.5	16.0	6	4.2	7.0	19	17	47	1/4	44
9	5.5	19.0	6	7.0	9.7	22	19	53	3/8	66
12	7.5	21.5	8	9.5	13.0	27	22	62	1/2	104
19	9.0	23.0	10	16.0	19.0	36	36	72	3/4	266
25	9.5	25.5	10	21.8	24.7	41	41	79	1	355

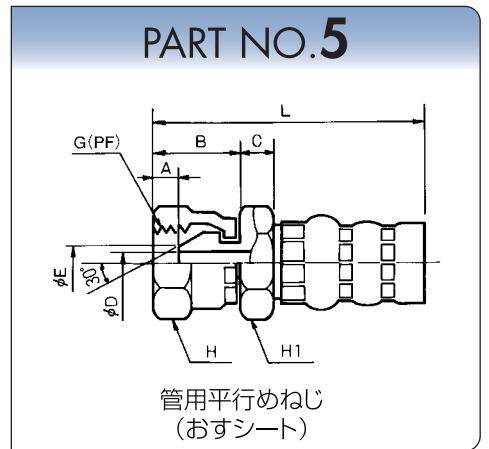

サイズ	A	B	C	D	E	H	H1	L	UNF	重量g
6	8.5	16.0	6	4.2	7.5	19	17	47	7/16-20	44
9	9.5	19.0	6	7.0	11.0	22	19	53	9/16-18	62
12	11.0	21.5	8	9.5	14.5	27	22	62	3/4-16	105
19	12.5	23.0	10	16.0	21.5	36	36	74	1 1/16-12	242
25	15.0	28.0	10	21.8	28.0	41	41	82	1 5/16-12	355

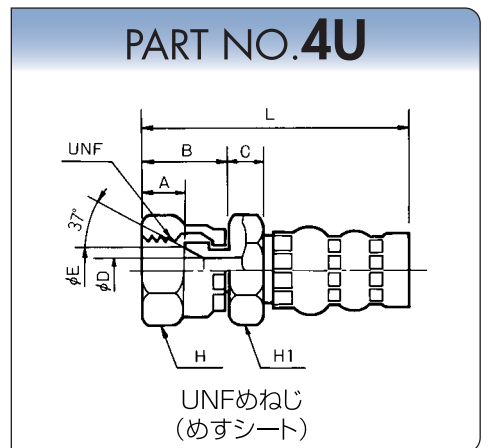

SIBシリーズ

SIB35

サイズ	A	D	E	F	H	J	L	G(PF)	重量g
6	8.5	4.2	9.5	34	19	26	49	1/4	45
9	9.5	6.5	13.0	47	22	34	60	3/8	79
12	10.5	9.5	16.0	54	27	39	69	1/2	114
19	12.5	16.0	22.0	70	36	50	87	3/4	415
25	12.5	21.0	28.0	87	41	59	100	1	640

PART NO.904

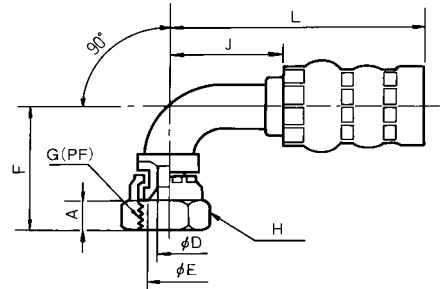

90°ベンドフィッティング
(めすシート)

サイズ	A	D	E	F	H	J	L	G(PF)	重量g
6	4.5	4.2	7.0	31.5	19	26	49	1/4	45
9	5.5	6.5	9.7	40	22	34	60	3/8	79
12	7.0	9.5	13.0	55	27	37	67	1/2	114
19	9.0	16.0	19.0	70	36	50	87	3/4	415
25	9.5	21.0	24.0	87	41	59	100	1	640

PART NO.905

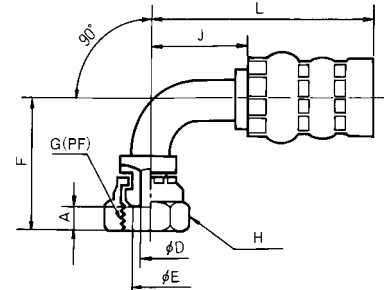

90°ベンドフィッティング
(おすシート)

サイズ	A	D	E	F	H	J	L	G(PF)	重量g
6	8.5	4.2	9.5	24	19	44	67	1/4	40
9	9.5	6.5	13.0	26	22	49.5	76	3/8	72
12	10.5	9.5	16.0	29.6	27	55.5	85	1/2	110
19	12.5	16.0	22.0	38	36	70	107	3/4	375
25	12.5	21.0	28.0	46.4	41	80	121	1	550

PART NO.454

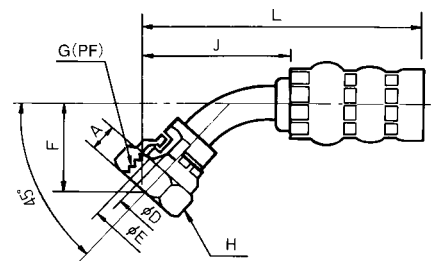

45°ベンドフィッティング
(めすシート)

サイズ	A	D	E	F	H	J	L	G(PF)	重量g
6	4.5	4.2	7.0	16.5	19	34.5	58	1/4	40
9	5.5	6.5	9.7	20.9	22	44.5	71	3/8	72
12	7.0	9.5	13.0	31.2	27	55.5	85	1/2	110
19	9.0	16.0	19.0	38	36	70	107	3/4	375
25	9.5	21.0	24.0	46.4	41	80	121	1	550

PART NO.455

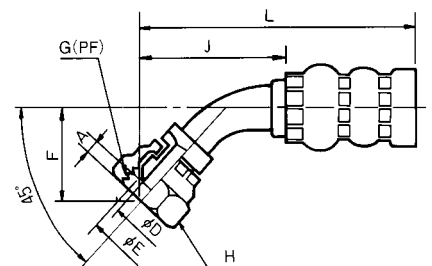

45°ベンドフィッティング
(おすシート)

SIBシリーズ

SIB35

サイズ	B	C	D	F	H	J	L	R (PT)	使用 Oリング	重量g
6	14	6	4.2	39	17	23	46	1/4	P-6	36
9	14	6	6.5	45	19	34	60	3/8	P-9	62
12	18	8	9.5	58	22	47	77	1/2	P-12	108

PART NO. SW901

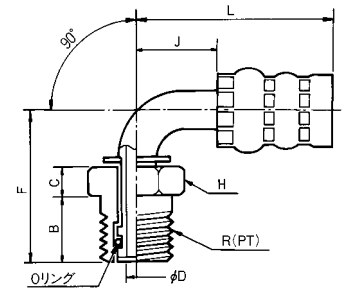

90°ベンドフィッティング
(おねじ簡易スイベルタイプ)

サイズ	B	C	D	F	H	J	L	G (PF)	使用Oリング		重量g
									1	2	
6	10.5	8	4.2	37.5	19	23	46	1/4	P-6	P-11	40
9	10.7	8	6.5	43.5	22	34	60	3/8	P-9	P-14	65
12	14.5	10	9.5	57	27	47	77	1/2	P-12	P-18	119

PART NO. SW902

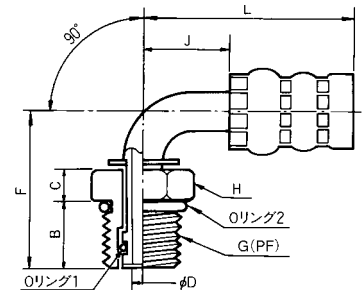

90°ベンドフィッティング
(平行ねじ簡易スイベルタイプ)

サイズ	B	C	D	F	H	J	L	R (PT)	使用 Oリング	重量g
6	14	6	4.2	22.6	17	38.6	62	1/4	P-6	33
9	14	6	6.5	24.3	19	47.8	74	3/8	P-9	57
12	18	8	9.5	30.7	22	63.1	93	1/2	P-12	100

PART NO. SW451

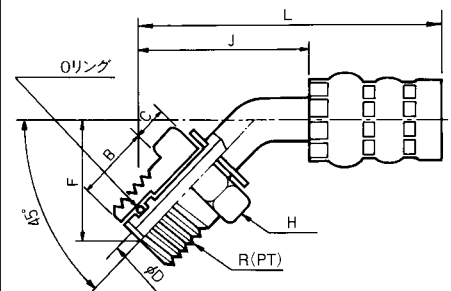

45°ベンドフィッティング
(おねじ簡易スイベルタイプ)

サイズ	B	C	D	F	H	J	L	G (PF)	使用Oリング		重量g
									1	2	
6	10.5	8	4.2	21.6	19	37.6	61	1/4	P-6	P-11	37
9	10.7	8	6.5	23.3	22	46.8	73	3/8	P-9	P-14	62
12	14.5	10	9.5	29.6	27	62.0	92	1/2	P-12	P-18	111

PART NO. SW452

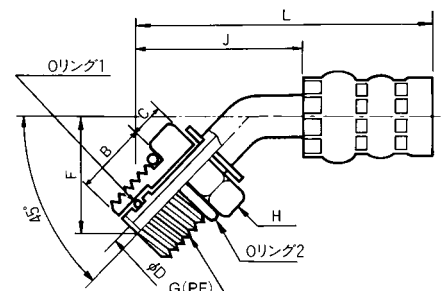

45°ベンドフィッティング
(平行ねじ簡易スイベルタイプ)

SIBシリーズ

SIB70

構造

内面ゴム: 耐油性合成ゴム
 補強層: 硬鋼線
 外面ゴム: 耐油・耐候性合成ゴム

適用流体

一般鉱物系作動油

温度範囲

-40℃~+100℃

ホース構造・補強層

1W/B



サイズ	補強層	内径 mm	外径 mm	最高使用圧力 MPa(kgf/cm ²)	最小破壊圧力 MPa(kgf/cm ²)	最小曲げ半径 mm	重量 g/m
6	1W/B	6.3	11.5	7.0(70)	35.0(350)	40	125
9	1W/B	9.5	15.2	7.0(70)	35.0(350)	50	170
12	1W/B	12.7	18.3	7.0(70)	35.0(350)	60	250
15	1W/B	15.9	22.1	7.0(70)	35.0(350)	80	400
19	1W/B	19.0	25.2	7.0(70)	35.0(350)	100	490
25	1W/B	25.4	31.6	7.0(70)	35.0(350)	120	620

サイズ	B	C	D	H	L		R(PT)		使用 Oリング	重量g
6	14	6	4.2	17	50		1/4		P-6	30
9	14	6	6.5	19	53		3/8		P-9	45
12	18	8	9.5	22	63		1/2		P-12	84

PART NO. SW1

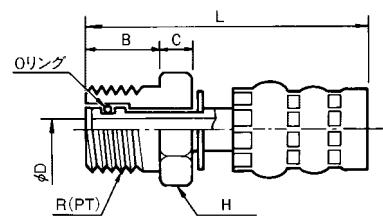

管用テーパードネジ
 (簡易スイベルタイプ)

サイズ	B	C	D	H	L	G(PF)	使用Oリング		重量g
							1	2	
6	10.5	8	4.2	19	49	1/4	P-6	P-11	34
9	10.7	8	6.5	22	52	3/8	P-9	P-14	50
12	14.5	10	9.5	27	62	1/2	P-12	P-18	95

PART NO. SW2

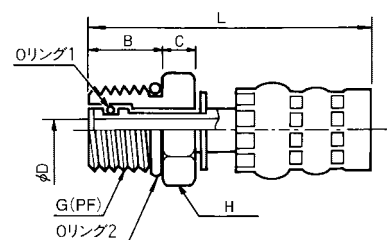

管用平行ドネジ
 (簡易スイベルタイプ)

SIBシリーズ

SIB70

サイズ	B	C	D	H			R (PT)	L	重量g
6	13	6	4.2	17			1/4	44	30
9	15	6	7.0	19			3/8	49	49
12	18	8	9.5	22			1/2	58	81
15	20	10	13.0	32			3/4	65	190
19	20	10	16.0	36			3/4	67	221
25	22	10	21.8	41			1	74	300

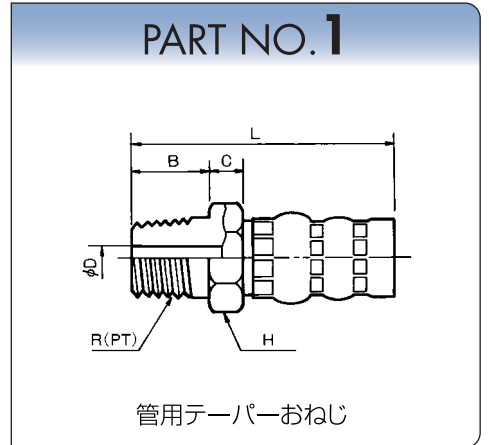

サイズ	A	B	C	D	E	H1	H2	G (PF)	L	重量g
6	8.5	16.0	6	4.2	9.5	19	17	1/4	47	42
9	9.5	19.0	6	7.0	13.0	22	19	3/8	53	61
12	11.0	21.5	8	9.5	16.0	27	22	1/2	62	98
15	12.5	23.0	10	13.0	22.0	36	32	3/4	68	220
19	12.5	23.0	10	16.0	22.0	36	36	3/4	70	266
25	12.5	25.5	10	21.8	28.0	41	41	1	77	300

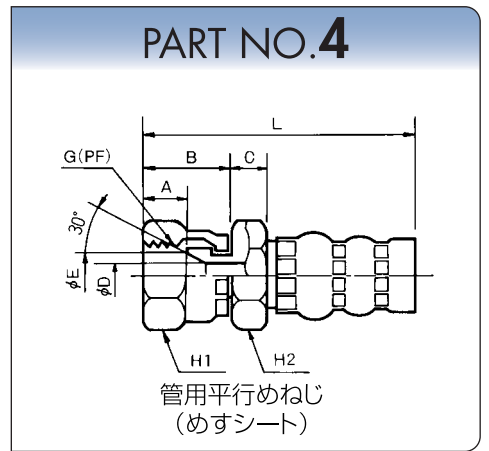

サイズ	A	B	C	D	E	H1	H2	G (PF)	L	重量g
6	4.5	16.0	6	4.2	7.0	19	17	1/4	47	44
9	5.5	19.0	6	7.0	9.7	22	19	3/8	53	66
12	7.5	21.5	8	9.5	13.0	27	22	1/2	62	104
15	9.0	23.0	10	13.0	19.0	36	32	3/4	68	220
19	9.0	23.0	10	16.0	19.0	36	36	3/4	70	266
25	9.5	25.5	10	21.8	24.7	41	41	1	77	355

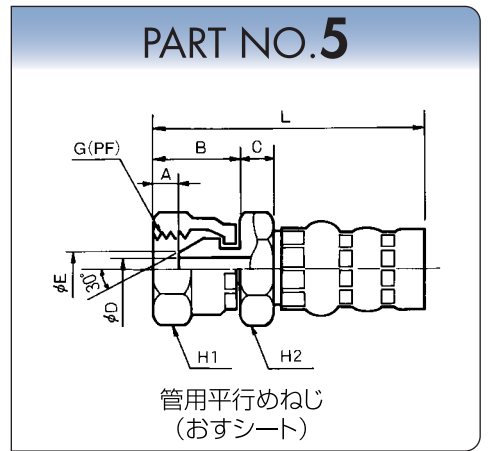

サイズ	A	B	C	D	E	H1	H2	UNF	L	重量g
6	8.5	16.0	6	4.2	7.5	19	17	7/16-20	47	44
9	9.5	19.0	6	7.0	11.0	22	19	9/16-18	53	62
12	11.0	21.5	8	9.5	14.5	27	22	3/4-16	62	105
15	12.0	23.5	10	13.0	17.5	27	27	7/8-14	69	220
19	12.5	23.0	10	16.0	21.5	36	36	1 1/16-12	72	242
25	15.0	28.0	10	21.8	28.0	41	41	1 5/16-12	80	355

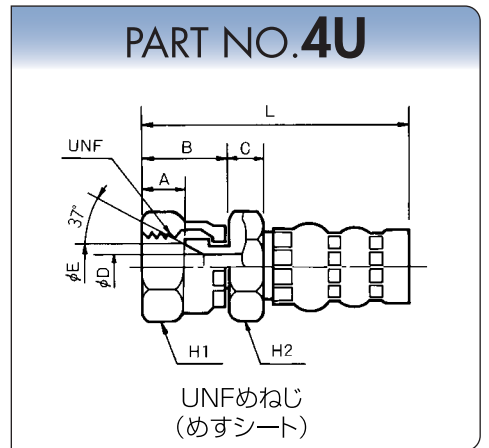

SIBシリーズ

SIB70

サイズ	A	D	E	F	H	J	G(PF)	L	重量g
6	8.5	4.2	9.5	34	19	26	1/4	49	45
9	9.5	6.5	13.0	47	22	34	3/8	60	79
12	10.5	9.5	16.0	54	27	39	1/2	69	114
15	12.5	12.6	22.0	70	36	50	3/4	83	380
19	12.5	16.0	22.0	70	36	50	3/4	85	415
25	12.5	21.0	28.0	87	41	59	1	98	640

PART NO.904

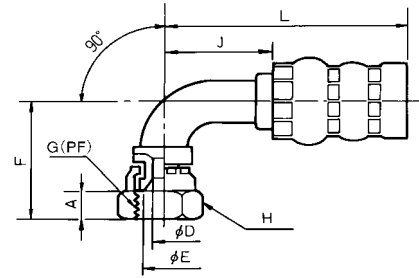

90°ベンドフィッティング
(めすシート)

サイズ	A	D	E	F	H	J	G(PF)	L	重量g
6	4.5	4.2	7.0	31.5	19	26	1/4	49	45
9	5.5	6.5	9.7	40	22	34	3/8	60	79
12	7.0	9.5	13.0	55	27	37	1/2	67	114
15	9.0	12.6	19.0	70	36	50	3/4	83	380
19	9.0	16.0	19.0	70	36	50	3/4	85	415
25	9.5	21.0	24.0	87	41	68	1	98	640

PART NO.905

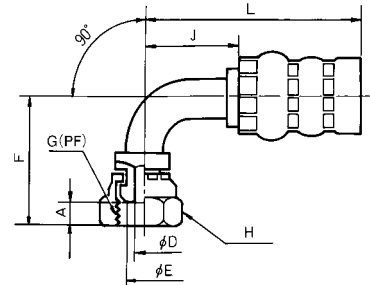

90°ベンドフィッティング
(おすシート)

サイズ	A	D	E	F	H	J	G(PF)	L	重量g
6	8.5	4.2	9.5	24	19	44	1/4	67	40
9	9.5	6.5	13.0	26	22	49.5	3/8	76	72
12	10.5	9.5	16.0	29.6	27	55.5	1/2	85	110
15	12.5	12.6	22.0	38	36	70	3/4	103	340
19	12.5	16.0	22.0	38	36	70	3/4	105	375
25	12.5	21.0	28.0	46.4	41	80	1	119	550

PART NO.454

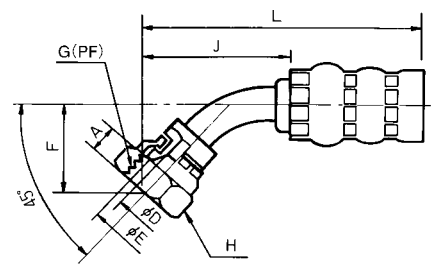

45°ベンドフィッティング
(めすシート)

サイズ	A	D	E	F	H	J	G(PF)	L	重量g
6	4.5	4.2	7.0	16.5	19	34.5	1/4	58	40
9	5.5	6.5	9.7	20.9	22	44.5	3/8	71	72
12	7.0	9.5	13.0	31.2	27	55.5	1/2	85	110
15	9.0	12.6	19.0	38	36	70	3/4	103	340
19	9.0	16.0	19.0	38	36	70	3/4	105	375
25	9.5	21.0	24.0	46.4	41	80	1	119	550

PART NO.455

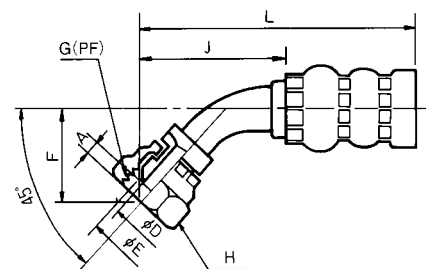

45°ベンドフィッティング
(おすシート)

SIBシリーズ

SIB70

サイズ	B	C	D	F	H	J	R(PT)	L	使用 Oリング	重量g
6	14	6	4.2	39	17	23	1/4	46	P-6	36
9	14	6	6.5	45	19	34	3/8	60	P-9	62
12	18	8	9.5	58	22	47	1/2	77	P-12	108

サイズ	B	C	D	F	H	J	L	G(PF)	使用Oリング		重量g
									1	2	
6	10.5	8	4.2	37.5	19	23	46	1/4	P-6	P-11	40
9	10.7	8	6.5	43.5	22	34	60	3/8	P-9	P-14	65
12	14.5	10	9.5	57	27	47	77	1/2	P-12	P-18	119

サイズ	B	C	D	F	H	J	R(PT)	L	使用 Oリング	重量g
6	14	6	4.2	22.6	17	38.6	1/4	62	P-6	33
9	14	6	6.5	24.3	19	47.8	3/8	74	P-9	57
12	18	8	9.5	30.7	22	63.1	1/2	93	P-12	100

サイズ	B	C	D	F	H	J	G(PF)	L	使用Oリング		重量g
									1	2	
6	10.5	8	4.2	21.6	19	37.6	1/4	61	P-6	P-11	37
9	10.7	8	6.5	23.3	22	46.8	3/8	73	P-9	P-14	62
12	14.5	10	9.5	29.6	27	62.0	1/2	92	P-12	P-18	111

PART NO. SW901

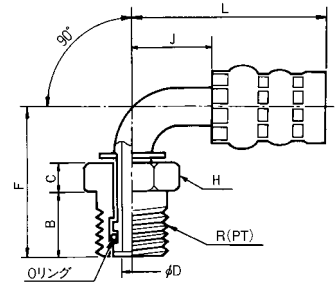

90°バンドフィッティング
(おねじ簡易スィベルタイプ)

PART NO. SW902

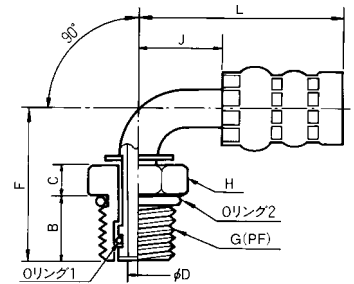

90°バンドフィッティング
(平行ねじ簡易スィベルタイプ)

PART NO. SW451

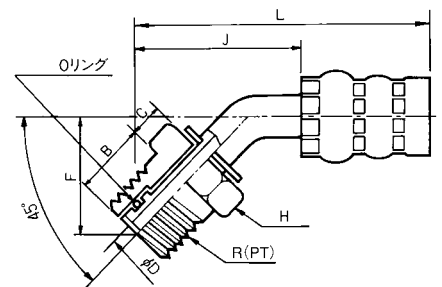

45°バンドフィッティング
(おねじ簡易スィベルタイプ)

PART NO. SW452

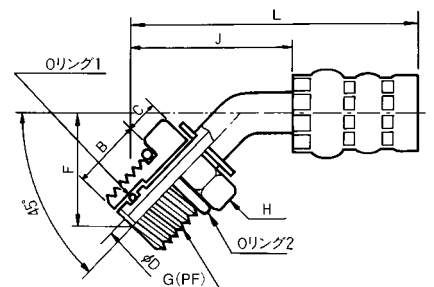

45°バンドフィッティング
(平行ねじ簡易スィベルタイプ)

SIBシリーズ

SIB105

構造

内面ゴム: 耐油性合成ゴム
 補強層: 硬鋼線
 外面ゴム: 耐油・耐候性合成ゴム

適用流体

一般鉱物系作動油

温度範囲

-40℃~+100℃

ホース構造・補強層

1W/B



サイズ	補強層	内径 mm	外径 mm	最高使用圧力 MPa(kgf/cm ²)	最小破壊圧力 MPa(kgf/cm ²)	最小曲げ半径 mm	重量 g/m
6	1W/B	6.3	11.5	10.5(105)	52.5(525)	40	125
9	1W/B	9.5	15.2	10.5(105)	52.5(525)	50	170
12	1W/B	12.7	19.5	10.5(105)	52.5(525)	60	330
15	1W/B	15.9	23.0	10.5(105)	52.5(525)	80	400
19	1W/B	19.0	25.2	10.5(105)	52.5(525)	100	490
25	1W/B	25.4	33.6	10.5(105)	52.5(525)	130	845

サイズ	B	C	D	H	R(PT)	L	使用 Oリング	重量g
6	14	6	4.2	17	1/4	50	P-6	30
9	14	6	6.5	19	3/8	53	P-9	56
12	18	8	9.5	22	1/2	64	P-12	99

PART NO. SW1

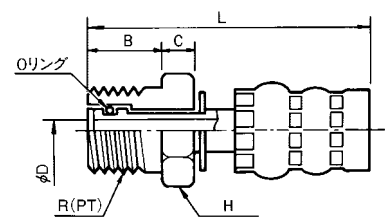

管用テーパードネジ
(簡易スイベルタイプ)

サイズ	B	C	D	H	G(PF)	L	使用Oリング		重量g
							1	2	
6	10.5	8	4.2	19	1/4	49	P-6	P-11	34
9	10.7	8	6.5	22	3/8	52	P-9	P-14	61
12	14.5	10	9.5	27	1/2	63	P-12	P-18	110

PART NO. SW2

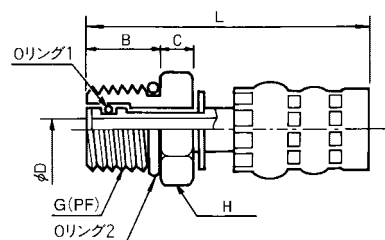

管用平行ドネジ
(簡易スイベルタイプ)

SIBシリーズ

SIB105

サイズ	B	C	D	H			R (PT)	L	重量g
6	13	6	4.2	17			1/4	44	30
9	15	6	7.0	19			3/8	49	60
12	18	8	9.5	22			1/2	59	96
15	20	10	13.0	32			3/4	65	190
19	20	10	16.0	36			3/4	67	221
25	22	10	21.8	41			1	76	300

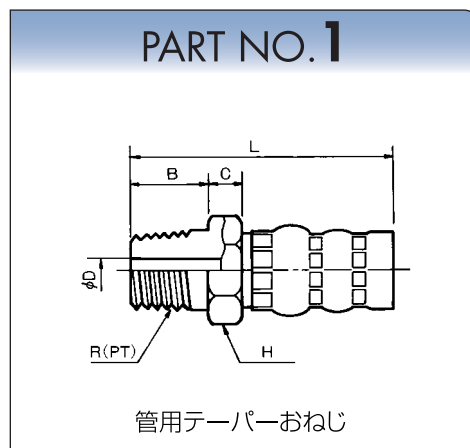

サイズ	A	B	C	D	E	H1	H2	G (PF)	L	重量g
6	8.5	16.0	6	4.2	9.5	19	17	1/4	47	42
9	9.5	19.0	6	7.0	13.0	22	19	3/8	53	72
12	11.0	21.5	8	9.5	16.0	27	22	1/2	63	113
15	12.5	23.0	10	13.0	22.0	36	32	3/4	68	220
19	12.5	23.0	10	16.0	22.0	36	36	3/4	70	266
25	12.5	25.5	10	21.8	28.0	41	41	1	79	300

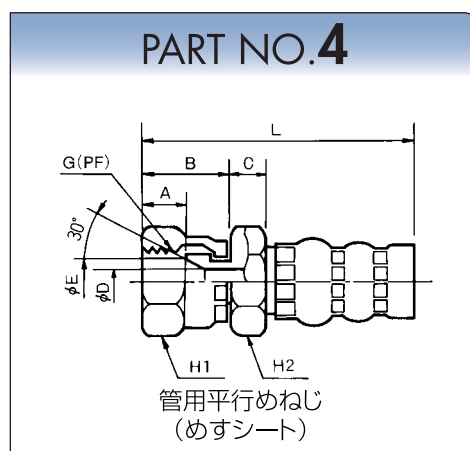

サイズ	A	B	C	D	E	H1	H2	G (PF)	L	重量g
6	4.5	16.0	6	4.2	7.0	19	17	1/4	47	44
9	5.5	19.0	6	7.0	9.7	22	19	3/8	53	77
12	7.5	21.5	8	9.5	13.0	27	22	1/2	63	119
15	9.0	23.0	10	13.0	19.0	36	32	3/4	68	220
19	9.0	23.0	10	16.0	19.0	36	36	3/4	70	266
25	9.5	25.5	10	21.8	24.7	41	41	1	79	355

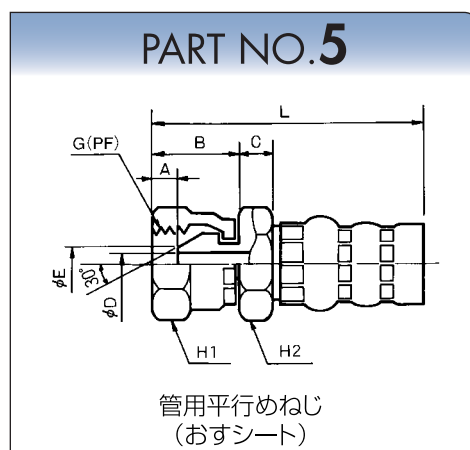

サイズ	A	B	C	D	E	H1	H2	UNF	L	重量g
6	8.5	16.0	6	4.2	7.5	19	17	7/16-20	47	44
9	9.5	19.0	6	7.0	11.0	22	19	9/16-18	53	73
12	11.0	21.5	8	9.5	14.5	27	22	3/4-16	63	120
15	12.0	23.5	10	13.0	17.5	27	27	7/8-14	69	220
19	12.5	23.0	10	16.0	21.5	36	36	1 1/16-12	72	242
25	15.0	28.0	10	21.8	28.0	41	41	1 5/16-12	82	355

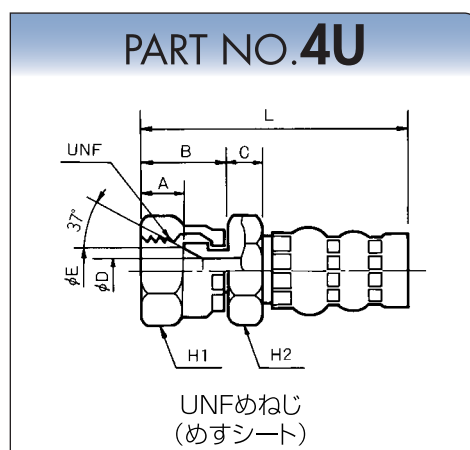

SIBシリーズ

SIB105

サイズ	A	D	E	F	H	J	G(PF)	L	重量g
6	8.5	4.2	9.5	34	19	26	1/4	49	45
9	9.5	6.5	13.0	47	22	34	3/8	60	90
12	10.5	9.5	16.0	54	27	39	1/2	70	129
15	12.5	12.6	22.0	70	36	50	3/4	83	380
19	12.5	16.0	22.0	70	36	50	3/4	85	415
25	12.5	21.0	28.0	87	41	59	1	100	640

PART NO.904

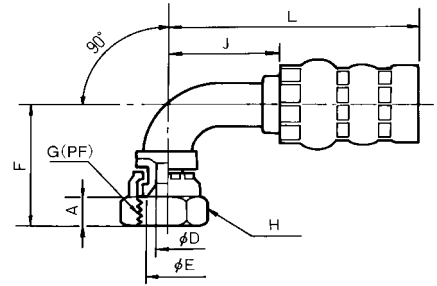

90°ベンドフィッティング
(めすシート)

サイズ	A	D	E	F	H	J	G(PF)	L	重量g
6	4.5	4.2	7.0	31.5	19	26	1/4	49	45
9	5.5	6.5	9.7	40	22	34	3/8	60	90
12	7.0	9.5	13.0	55	27	37	1/2	68	129
15	9.0	12.6	19.0	70	36	50	3/4	83	380
19	9.0	16.0	19.0	70	36	50	3/4	85	415
25	9.5	21.0	24.0	87	41	59	1	100	640

PART NO.905

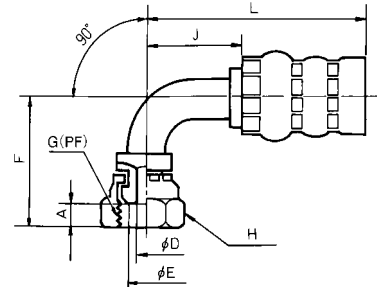

90°ベンドフィッティング
(おすシート)

サイズ	A	D	E	F	H	J	G(PF)	L	重量g
6	8.5	4.2	9.5	24	19	44	1/4	67	40
9	9.5	6.5	13.0	26	22	49.5	3/8	76	83
12	10.5	9.5	16.0	29.6	27	55.5	1/2	86	125
15	12.5	12.6	22.0	38	36	70	3/4	103	340
19	12.5	16.0	22.0	38	36	70	3/4	105	375
25	12.5	21.0	28.0	46.4	41	80	1	121	550

PART NO.454

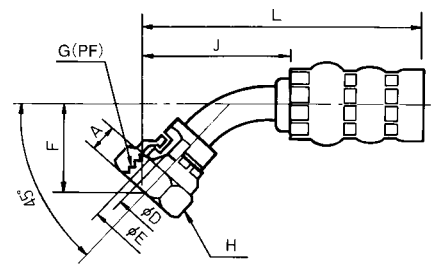

45°ベンドフィッティング
(めすシート)

サイズ	A	D	E	F	H	J	G(PF)	L	重量g
6	4.5	4.2	7.0	16.5	19	34.5	1/4	58	40
9	5.5	6.5	9.7	20.9	22	44.5	3/8	71	83
12	7.0	9.5	13.0	31.2	27	55.5	1/2	86	125
15	9.0	12.6	19.0	38	36	70	3/4	103	340
19	9.0	16.0	19.0	38	36	70	3/4	105	375
25	9.5	21.0	24.0	46.4	41	80	1	121	550

PART NO.455

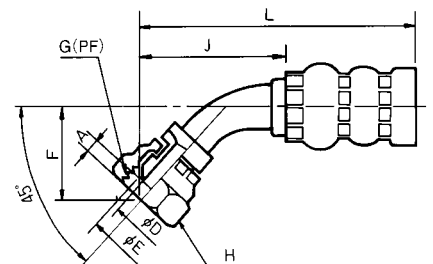

45°ベンドフィッティング
(おすシート)

SIBシリーズ

SIB105

サイズ	B	C	D	F	H	J	R(PT)	L	使用 Oリング	重量g
6	14	6	4.2	39	17	23	1/4	46	P-6	36
9	14	6	6.5	45	19	34	3/8	60	P-9	73
12	18	8	9.5	58	22	47	1/2	78	P-12	123

PART NO. SW901

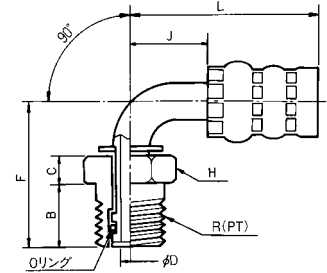

90°バンドフィッティング
(おねじ簡易スイベルタイプ)

サイズ	B	C	D	F	H	J	G(PF)	L	使用Oリング		重量g
									1	2	
6	10.5	8	4.2	37.5	19	23	1/4	46	P-6	P-11	40
9	10.7	8	6.5	43.5	22	34	3/8	60	P-9	P-14	76
12	14.5	10	9.5	57	27	47	1/2	78	P-12	P-18	134

PART NO. SW902

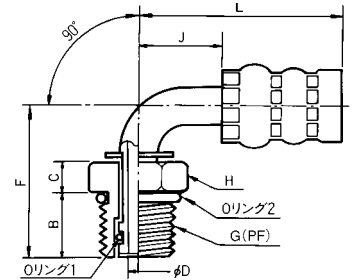

90°バンドフィッティング
(平行ねじ簡易スイベルタイプ)

サイズ	B	C	D	F	H	J	R(PT)	L	使用 Oリング	重量g
6	14	6	4.2	22.6	17	38.6	1/4	62	P-6	33
9	14	6	6.5	24.3	19	47.8	3/8	74	P-9	68
12	18	8	9.5	30.7	22	63.1	1/2	94	P-12	115

PART NO. SW451

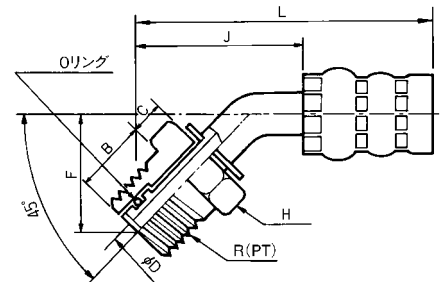

45°バンドフィッティング
(おねじ簡易スイベルタイプ)

サイズ	B	C	D	F	H	J	G(PF)	L	使用Oリング		重量g
									1	2	
6	10.5	8	4.2	21.6	19	37.6	1/4	61	P-6	P-11	37
9	10.7	8	6.5	23.3	22	46.8	3/8	73	P-9	P-14	73
12	14.5	10	9.5	29.6	27	62	1/2	93	P-12	P-18	126

PART NO. SW452

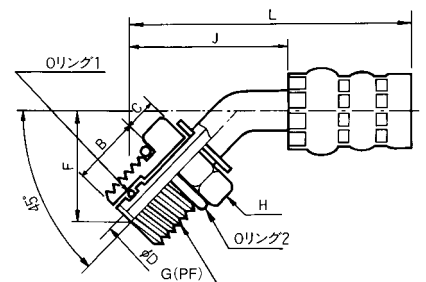

45°バンドフィッティング
(平行ねじ簡易スイベルタイプ)

SIBシリーズ

SIB140

構造

内面ゴム: 耐油性合成ゴム
 補強層: 硬鋼線
 外面ゴム: 耐油・耐候性合成ゴム

適用流体

一般鉱物系作動油

温度範囲

-40℃~+100℃

ホース構造・補強層

1W/B



2W/B



サイズ	補強層	内径 mm	外径 mm	最高使用圧力 MPa(kgf/cm ²)	最小破壊圧力 MPa(kgf/cm ²)	最小曲げ半径 mm	重量 g/m
6	1W/B	6.3	11.5	14.0(140)	70.0(700)	45	135
9	1W/B	9.5	15.4	14.0(140)	70.0(700)	55	230
12	1W/B	12.7	19.5	14.0(140)	70.0(700)	70	330
15	1W/B	15.9	23.0	14.0(140)	70.0(700)	95	460
19	1W/B	19.0	27.2	14.0(140)	70.0(700)	110	670
25	2W/B	25.4	34.8	14.0(140)	70.0(700)	140	1095

サイズ	B	C	D	H	R(PT)	L	使用 Oリング	重量g
6	14	6	4.2	17	1/4	50	P-6	36
9	14	6	6.5	19	3/8	53	P-9	56
12	18	8	9.5	22	1/2	64	P-12	99

PART NO. SW1

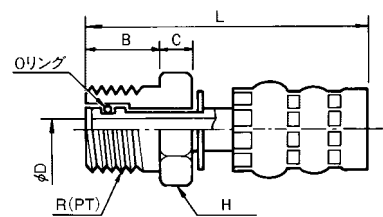

管用テーパおねじ
(簡易スイベルタイプ)

サイズ	B	C	D	H	G(PF)	L	使用Oリング		重量g
							1	2	
6	10.5	8	4.2	19	1/4	49	P-6	P-11	40
9	10.7	8	6.5	22	3/8	52	P-9	P-14	61
12	14.5	10	9.5	27	1/2	63	P-12	P-18	110

PART NO. SW2

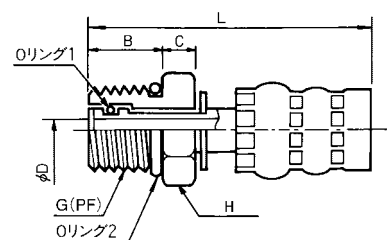

管用平行おねじ
(簡易スイベルタイプ)

SIBシリーズ

SIB140

サイズ	B	C	D	H			R (PT)	L	重量g
6	13	6	4.2	17			1/4	44	36
9	15	6	7.0	19			3/8	49	60
12	18	8	9.5	22			1/2	59	96
15	20	10	13.0	32			3/4	65	190
19	20	10	16.0	36			3/4	69	221
25	22	10	21.8	41			1	76	300

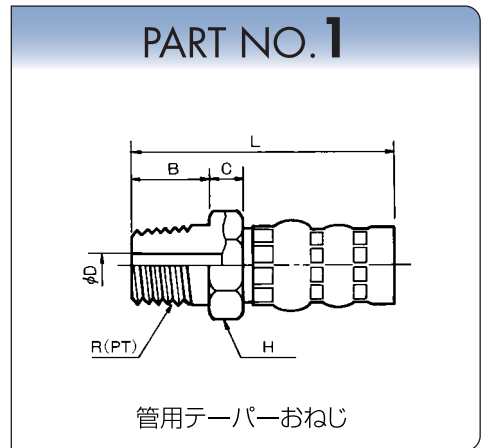

サイズ	A	B	C	D	E	H1	H2	G (PF)	L	重量g
6	8.5	16.0	6	4.2	9.5	19	17	1/4	47	48
9	9.5	19.0	6	7.0	13.0	22	19	3/8	53	72
12	11.0	21.5	8	9.5	16.0	27	22	1/2	63	113
15	12.5	23.0	10	13.0	22.0	36	32	3/4	68	220
19	12.5	23.0	10	16.0	22.0	36	36	3/4	72	266
25	12.5	25.5	10	21.8	28.0	41	41	1	79	300

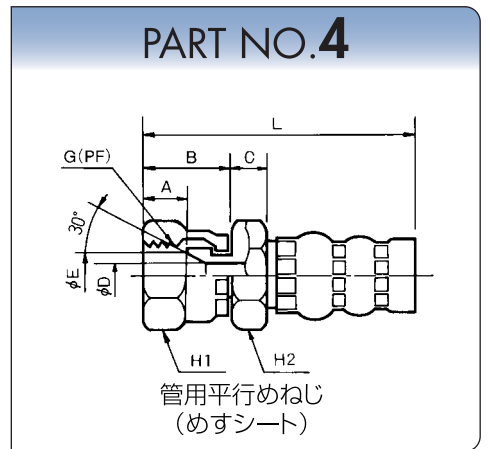

サイズ	A	B	C	D	E	H1	H2	G (PF)	L	重量g
6	4.5	16.0	6	4.2	7.0	19	17	1/4	47	50
9	5.5	19.0	6	7.0	9.7	22	19	3/8	53	77
12	7.5	21.5	8	9.5	13.0	27	22	1/2	63	119
15	9.0	23.0	10	13.0	19.0	36	32	3/4	68	220
19	9.0	23.0	10	16.0	19.0	36	36	3/4	72	266
25	9.5	25.5	10	21.8	24.7	41	41	1	79	355

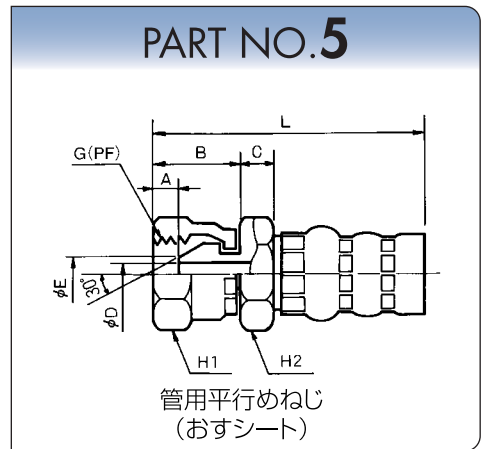

サイズ	A	B	C	D	E	H1	H2	L	UNF	重量g
6	8.5	16.0	6	4.2	7.5	19	17	47	7/16-20	50
9	9.5	19.0	6	7.0	11.0	22	19	53	9/16-18	73
12	11.0	21.5	8	9.5	14.5	27	22	63	3/4-16	120
15	12.0	23.5	10	13.0	17.5	27	27	69	7/8-14	220
19	12.5	23.0	10	16.0	21.5	36	36	74	1 1/16-12	242
25	15.0	28.0	10	21.8	28.0	41	41	82	1 5/16-12	355

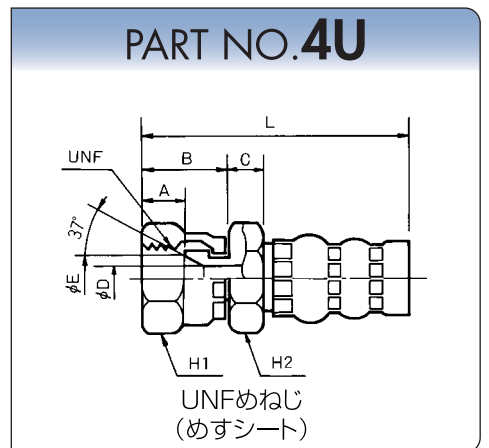

SIBシリーズ

SIB140

サイズ	A	D	E	F	H	J	G (PF)	L	重量g
6	8.5	4.2	9.5	34	19	26	1/4	49	51
9	9.5	6.5	13.0	47	22	34	3/8	60	90
12	10.5	9.5	16.0	54	27	39	1/2	70	129
15	12.5	12.6	22.0	70	36	50	3/4	83	380
19	12.5	16.0	22.0	70	36	50	3/4	87	415
25	12.5	21.0	28.0	87	41	59	1	100	640

PART NO.904

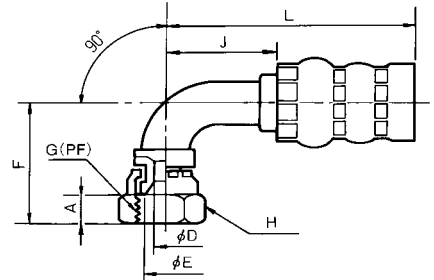

90°ベンドフィッティング
(めすシート)

サイズ	A	D	E	F	H	J	G (PF)	L	重量g
6	4.5	4.2	7.0	31.5	19	26	1/4	49	51
9	5.5	6.5	9.7	40	22	34	3/8	60	90
12	7.0	9.5	13.0	55	27	37	1/2	68	129
15	9.0	12.6	19.0	70	36	50	3/4	83	380
19	9.0	16.0	19.0	70	36	50	3/4	87	415
25	9.5	21.0	24.0	87	41	59	1	100	640

PART NO.905

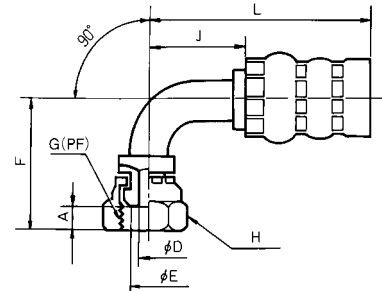

90°ベンドフィッティング
(おすシート)

サイズ	A	D	E	F	H	J	G (PF)	L	重量g
6	8.5	4.2	9.5	24	19	44	1/4	67	46
9	9.5	6.5	13.0	26	22	49.5	3/8	76	83
12	10.5	9.5	16.0	29.6	27	55.5	1/2	86	125
15	12.5	12.6	22.0	38	36	70	3/4	103	340
19	12.5	16.0	22.0	38	36	70	3/4	107	375
25	12.5	21.0	28.0	46.4	41	80	1	121	550

PART NO.454

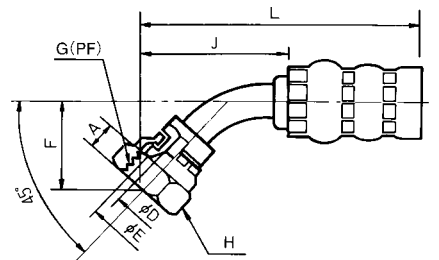

45°ベンドフィッティング
(めすシート)

サイズ	A	D	E	F	H	J	G (PF)	L	重量g
6	4.5	4.2	7.0	16.5	19	34.5	1/4	58	46
9	5.5	6.5	9.7	20.9	22	44.5	3/8	71	83
12	7.0	9.5	13.0	31.2	27	55.5	1/2	86	125
15	9.0	12.6	19.0	38	36	70	3/4	103	340
19	9.0	16.0	19.0	38	36	70	3/4	107	375
25	9.5	21.0	24.0	46.4	41	80	1	121	550

PART NO.455

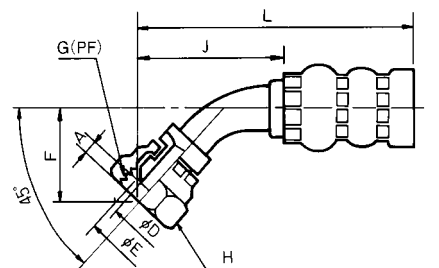

45°ベンドフィッティング
(おすシート)

SIBシリーズ

SIB140

サイズ	B	C	D	F	H	J	R(PT)	L	使用 Oリング	重量g
6	14	6	4.2	39	17	23	1/4	46	P-6	42
9	14	6	6.5	45	19	34	3/8	60	P-9	73
12	18	8	9.5	58	22	47	1/2	78	P-12	123

サイズ	B	C	D	F	H	J	G(PF)	L	使用Oリング		重量g
									1	2	
6	10.5	8	4.2	37.5	19	23	1/4	46	P-6	P-11	46
9	10.7	8	6.5	43.5	22	34	3/8	60	P-9	P-14	76
12	14.5	10	9.5	57	27	47	1/2	78	P-12	P-18	134

サイズ	B	C	D	F	H	J	R(PT)	L	使用 Oリング	重量g
6	14	6	4.2	22.6	17	38.6	1/4	62	P-6	39
9	14	6	6.5	24.3	19	47.8	3/8	74	P-9	68
12	18	8	9.5	30.7	22	63.1	1/2	94	P-12	115

サイズ	B	C	D	F	H	J	G(PF)	L	使用Oリング		重量g
									1	2	
6	10.5	8	4.2	21.6	19	37.6	1/4	61	P-6	P-11	43
9	10.7	8	6.5	23.3	22	46.8	3/8	73	P-9	P-14	73
12	14.5	10	9.5	29.6	27	62	1/2	93	P-12	P-18	126

PART NO. SW901

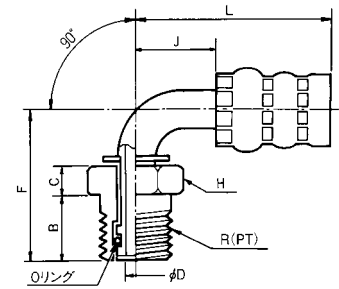

90°バンドフィッティング
(おねじ簡易スイベルタイプ)

PART NO. SW902

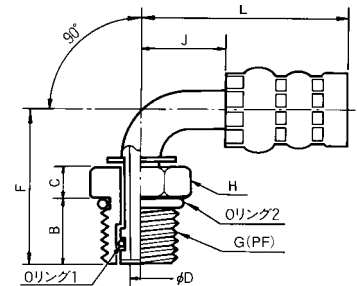

90°バンドフィッティング
(平行ねじ簡易スイベルタイプ)

PART NO. SW451

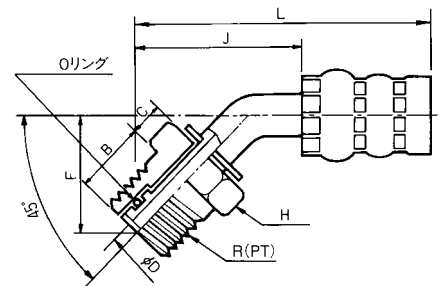

45°バンドフィッティング
(おねじ簡易スイベルタイプ)

PART NO. SW452

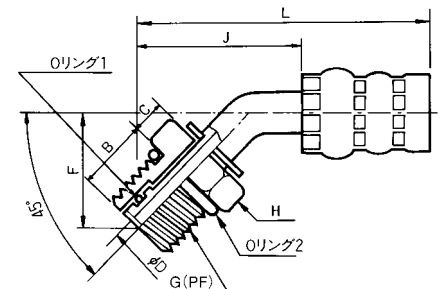

45°バンドフィッティング
(平行ねじ簡易スイベルタイプ)

SIBシリーズ

SIB175

構造

内面ゴム: 耐油性合成ゴム
補強層: 硬鋼線
外面ゴム: 耐油・耐候性合成ゴム

適用流体

一般鉱物系作動油

温度範囲

-40℃~+100℃

ホース構造・補強層

1W/B



3W/B



2W/B



サイズ	補強層	内径 mm	外径 mm	最高使用圧力 MPa(kgf/cm ²)	最小破壊圧力 MPa(kgf/cm ²)	最小曲げ半径 mm	重量 g/m
6	1W/B	6.3	11.5	17.0(175)	85.0(875)	45	135
9	2W/B	9.5	16.6	17.0(175)	85.0(875)	65	340
12	2W/B	12.7	20.8	17.0(175)	85.0(875)	85	530
15	2W/B	15.9	25.0	17.0(175)	85.0(875)	100	720
19	2W/B	19.0	28.4	17.0(175)	85.0(875)	120	900
25	3W/B	25.4	36.5	17.0(175)	85.0(875)	170	1,510

サイズ	B	C	D	H	L	R(PT)	使用 Oリング	重量g
6	14	6	4.2	17	50	1/4	P-6	36
9	14	6	6.5	19	53	3/8	P-9	56
12	18	8	9.5	22	64	1/2	P-12	99

PART NO. SW1

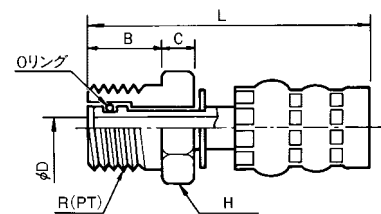

管用テーパおねじ
(簡易スイベルタイプ)

サイズ	B	C	D	H	L	G(PF)	L	使用Oリング		重量g
								1	2	
6	10.5	8	4.2	19		1/4	49	P-6	P-11	40
9	10.7	8	6.5	22		3/8	52	P-9	P-14	61
12	14.5	10	9.5	27		1/2	63	P-12	P-18	110

PART NO. SW2

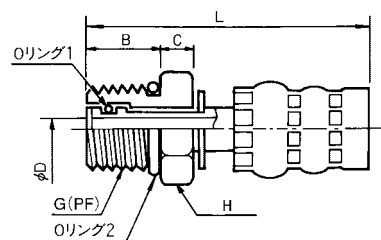

管用平行おねじ
(簡易スイベルタイプ)

SIBシリーズ

SIB175

サイズ	B	C	D	H	L	R (PT)	重量g
6	13	6	4.2	17	44	1/4	36
9	15	6	7.0	19	49	3/8	60
12	18	8	9.5	22	59	1/2	96
15	20	10	13.0	32	67	3/4	190
19	20	10	16.0	36	69	3/4	221
25	22	12	21.8	41	83	1	330

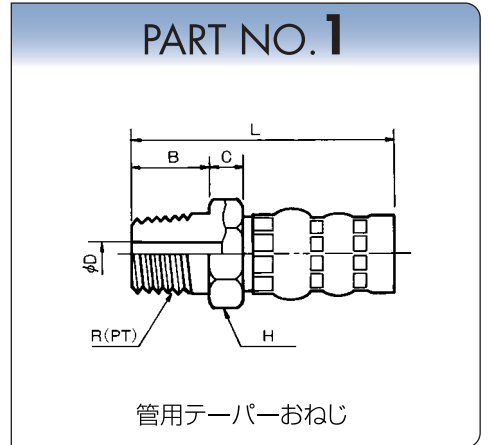

サイズ	A	B	C	D	E	H1	H2	G (PF)	L	重量g
6	8.5	16.0	6	4.2	9.5	19	17	1/4	47	48
9	9.5	19.0	6	7.0	13.0	22	19	3/8	53	72
12	11.0	21.5	8	9.5	16.0	27	22	1/2	63	113
15	12.5	23.0	10	13.0	22.0	36	32	3/4	70	220
19	12.5	23.0	10	16.0	22.0	36	36	3/4	72	266
25	12.5	25.5	12	21.8	28.0	41	41	1	87	330

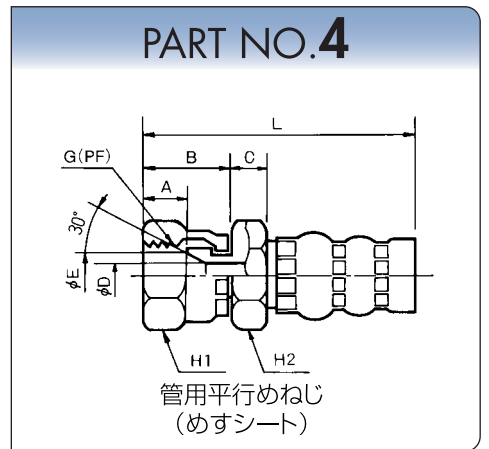

サイズ	A	B	C	D	E	H1	H2	G (PF)	L	重量g
6	4.5	16.0	6	4.2	7.0	19	17	1/4	47	50
9	5.5	19.0	6	7.0	9.7	22	19	3/8	53	77
12	7.5	21.5	8	9.5	13.0	27	22	1/2	63	119
15	9.0	23.0	10	13.0	19.0	36	32	3/4	70	220
19	9.0	23.0	10	16.0	19.0	36	36	3/4	72	266
25	9.5	25.5	12	21.8	24.0	41	41	1	87	385

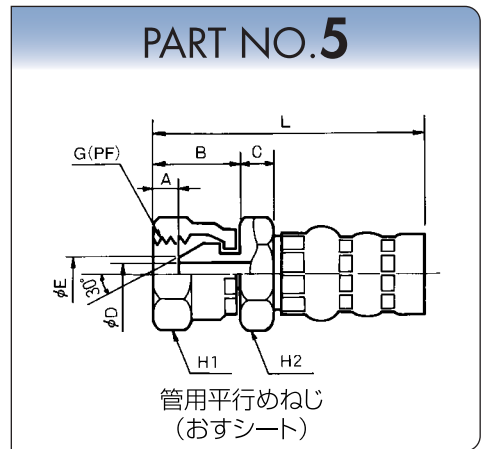

サイズ	A	B	C	D	E	H1	H2	L	UNF	重量g
6	8.5	16.0	6	4.2	7.5	19	17	47	7/16-20	50
9	9.5	19.0	6	7.0	11.0	22	19	53	9/16-18	73
12	11.0	21.5	8	9.5	14.5	27	22	63	3/4-16	120
15	12.0	23.5	10	13.0	17.5	27	27	71	7/8-14	220
19	12.5	23.0	10	16.0	21.5	36	36	74	1 1/16-12	242
25	15.0	28.0	12	21.8	28.0	41	41	89	1 5/16-12	385

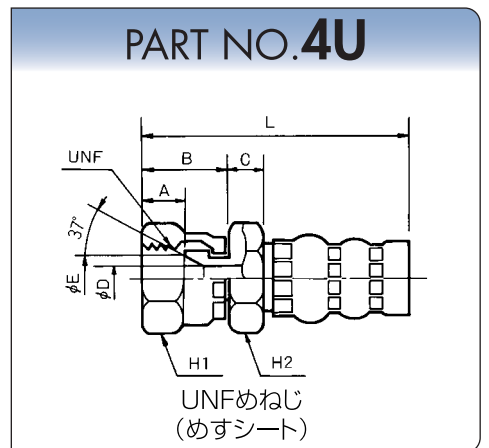

SIBシリーズ

SIB175

サイズ	A	D	E	F	H	J	G(PF)	L	重量g
6	8.5	4.2	9.5	34	19	26	1/4	49	51
9	9.5	6.5	13.0	47	22	34	3/8	60	90
12	10.5	9.5	16.0	54	27	39	1/2	70	129
15	12.5	12.6	22.0	70	36	50	3/4	85	380
19	12.5	16.0	22.0	70	36	50	3/4	87	415
25	12.5	21.0	28.0	87	41	68	1	115	710

PART NO.904

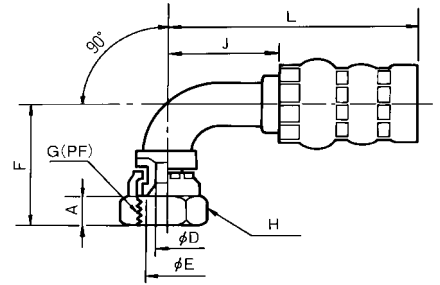

90°ベンドフィッティング
(めすシート)

サイズ	A	D	E	F	H	J	G(PF)	L	重量g
6	4.5	4.2	7.0	31.5	19	26	1/4	49	51
9	5.5	6.5	9.7	40	22	34	3/8	60	90
12	7.0	9.5	13.0	55	27	37	1/2	68	129
15	9.0	12.6	19.0	70	36	50	3/4	85	380
19	9.0	16.0	19.0	70	36	50	3/4	87	415
25	9.5	21.0	24.0	87	41	68	1	115	710

PART NO.905

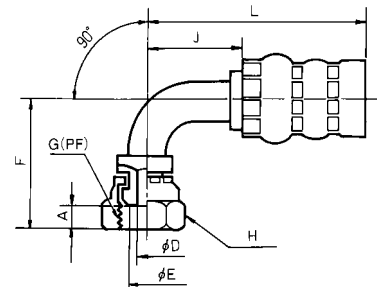

90°ベンドフィッティング
(おすシート)

サイズ	A	D	E	F	H	J	G(PF)	L	重量g
6	8.5	4.2	9.5	24	19	44	1/4	67	46
9	9.5	6.5	13.0	26	22	49.5	3/8	76	83
12	10.5	9.5	16.0	29.6	27	55.5	1/2	86	125
15	12.5	12.6	22.0	38	36	70	3/4	105	340
19	12.5	16.0	22.0	38	36	70	3/4	107	375
25	12.5	21.0	28.0	46.4	41	84.5	1	132	620

PART NO.454

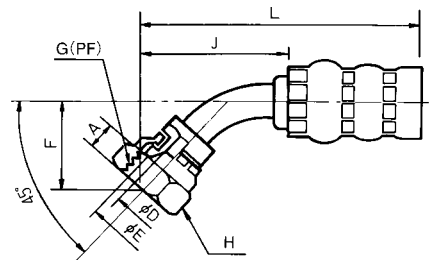

45°ベンドフィッティング
(めすシート)

サイズ	A	D	E	F	H	J	G(PF)	L	重量g
6	4.5	4.2	7.0	16.5	19	34.5	1/4	58	46
9	5.5	6.5	9.7	20.9	22	44.5	3/8	71	83
12	7.0	9.5	13.0	31.2	27	55.5	1/2	86	125
15	9.0	12.6	19.0	38	36	70	3/4	105	340
19	9.0	16.0	19.0	38	36	70	3/4	107	375
25	9.5	21.0	24.0	46.4	41	84.5	1	132	620

PART NO.455

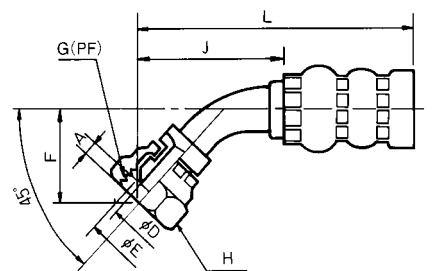

45°ベンドフィッティング
(おすシート)

SIBシリーズ

SIB175

サイズ	B	C	D	F	H	J	R(PT)	L	使用 Oリング	重量g
6	14	6	4.2	39	17	23	1/4	46	P-6	42
9	14	6	6.5	45	19	34	3/8	60	P-9	73
12	18	8	9.5	58	22	47	1/2	78	P-12	123

PART NO. SW901

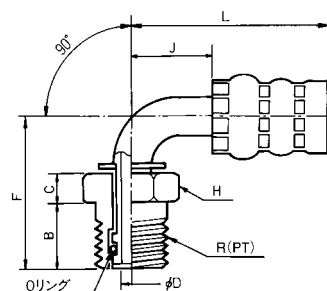

90°バンドフィッティング
(おねじ簡易スイベルタイプ)

サイズ	B	C	D	F	H	J	G(PF)	L	使用Oリング		重量g
									1	2	
6	10.5	8	4.2	37.5	19	23	1/4	46	P-6	P-11	46
9	10.7	8	6.5	43.5	22	34	3/8	60	P-9	P-14	76
12	14.5	10	9.5	57	27	47	1/2	78	P-12	P-18	134

PART NO. SW902

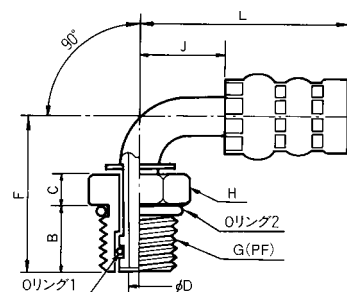

90°バンドフィッティング
(平行ねじ簡易スイベルタイプ)

サイズ	B	C	D	F	H	J	L	R(PT)	使用 Oリング	重量g
6	14	6	4.2	22.6	17	38.6	62	1/4	P-6	39
9	14	6	6.5	24.3	19	47.8	74	3/8	P-9	68
12	18	8	9.5	30.7	22	63.1	94	1/2	P-12	115

PART NO. SW451

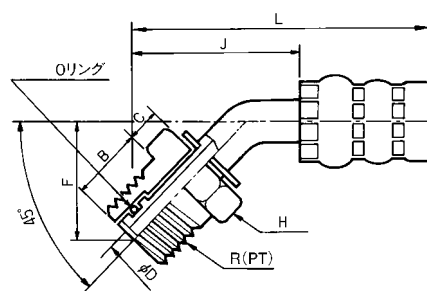

45°バンドフィッティング
(おねじ簡易スイベルタイプ)

サイズ	B	C	D	F	H	J	L	G(PF)	使用Oリング		重量g
									1	2	
6	10.5	8	4.2	21.6	19	37.6	61	1/4	P-6	P-11	43
9	10.7	8	6.5	23.3	22	46.8	73	3/8	P-9	P-14	73
12	14.5	10	9.5	29.6	27	62	93	1/2	P-12	P-18	126

PART NO. SW452

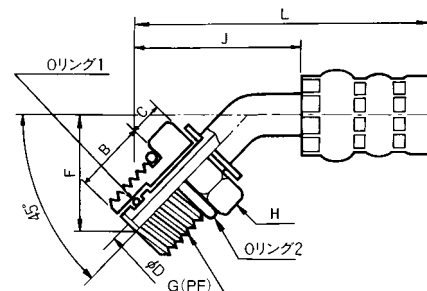

45°バンドフィッティング
(平行ねじ簡易スイベルタイプ)

SIBシリーズ

SIB210

構造

内面ゴム: 耐油性合成ゴム
 補強層: 硬鋼線
 外面ゴム: 耐油・耐候性合成ゴム

適用流体

一般鉱物系作動油

温度範囲

-40°C~+100°C

ホース構造・補強層

1W/B



3W/B



2W/B



サイズ	補強層	内径 mm	外径 mm	最高使用圧力 MPa(kgf/cm ²)	最小破壊圧力 MPa(kgf/cm ²)	最小曲げ半径 mm	重量 g/m
6	1W/B	6.3	12.5	20.5(210)	102.5(1050)	50	190
9	2W/B	9.5	16.6	20.5(210)	102.5(1050)	70	340
12	2W/B	12.7	20.8	20.5(210)	102.5(1050)	90	530
15	2W/B	15.9	25.0	20.5(210)	102.5(1050)	110	730
19	2W/B	19.0	28.4	20.5(210)	102.5(1050)	130	900
25	3W/B	25.4	36.5	20.5(210)	102.5(1050)	180	1,510

サイズ	B	C	D	H	R(PT)	L	使用 Oリング	重量g
6	14	6	4.2	17	1/4	50	P-6	36
9	14	6	6.5	19	3/8	53	P-9	56
12	18	8	9.5	22	1/2	64	P-12	99

PART NO. SW1

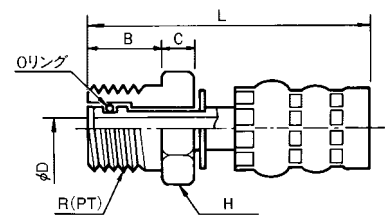

管用テーパおねじ
(簡易スイベルタイプ)

サイズ	B	C	D	H	G(PF)	L	使用Oリング		重量g
							1	2	
6	10.5	8	4.2	19	1/4	49	P-6	P-11	40
9	10.7	8	6.5	22	3/8	52	P-9	P-14	61
12	14.5	10	9.5	27	1/2	63	P-12	P-18	110

PART NO. SW2

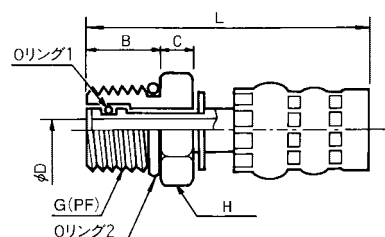

管用平行おねじ
(簡易スイベルタイプ)

SIBシリーズ

SIB210

サイズ	B	C	D	H			R (PT)	L	重量g
6	13	6	4.2	17			1/4	44	36
9	15	6	7.0	19			3/8	49	60
12	18	8	9.5	22			1/2	59	96
15	20	10	13.0	32			3/4	67	190
19	20	10	16.0	36			3/4	69	221
25	22	12	21.8	41			1	83	330

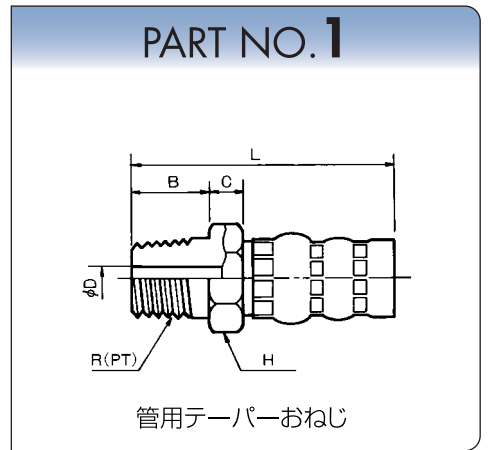

サイズ	A	B	C	D	E	H1	H2	G (PF)	L	重量g
6	8.5	16.0	6	4.2	9.5	19	17	1/4	47	48
9	9.5	19.0	6	7.0	13.0	22	19	3/8	53	72
12	11.0	21.5	8	9.5	16.0	27	22	1/2	63	113
15	12.5	23.0	10	13.0	22.0	36	32	3/4	70	220
19	12.5	23.0	10	16.0	22.0	36	36	3/4	72	266
25	12.5	25.5	12	21.8	28.0	41	41	1	87	330

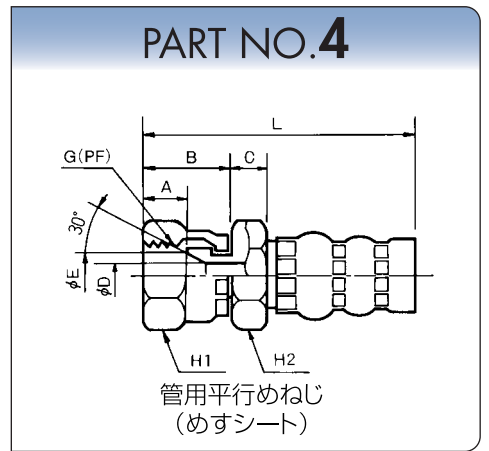

サイズ	A	B	C	D	E	H1	H2	G (PF)	L	重量g
6	4.5	16.0	6	4.2	7.0	19	17	1/4	47	50
9	5.5	19.0	6	7.0	9.7	22	19	3/8	53	77
12	7.5	21.5	8	9.5	13.0	27	22	1/2	63	119
15	9.0	23.0	10	13.0	19.0	36	32	3/4	70	220
19	9.0	23.0	10	16.0	19.0	36	36	3/4	72	266
25	9.5	25.5	12	21.8	24.0	41	41	1	87	385

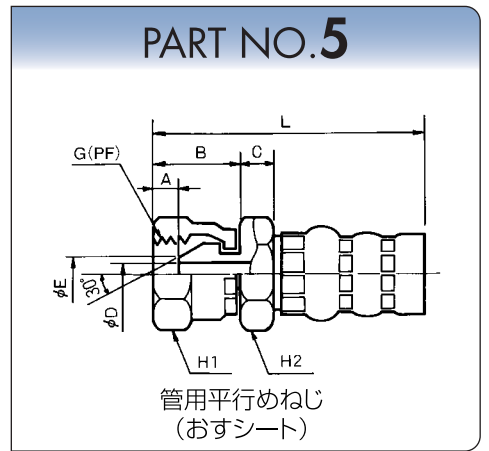

サイズ	A	B	C	D	E	H1	H2	UNF	L	重量g
6	8.5	16.0	6	4.2	7.5	19	17	7/16-20	47	50
9	9.5	19.0	6	7.0	11.0	22	19	9/16-18	53	73
12	11.0	21.5	8	9.5	14.5	27	22	3/4-16	63	120
15	12.0	23.5	10	13.0	17.5	27	27	7/8-14	71	220
19	12.5	23.0	10	16.0	21.5	36	36	1 1/16-12	73	242
25	15.0	28.0	12	21.8	28.0	41	41	1 5/16-12	89	385

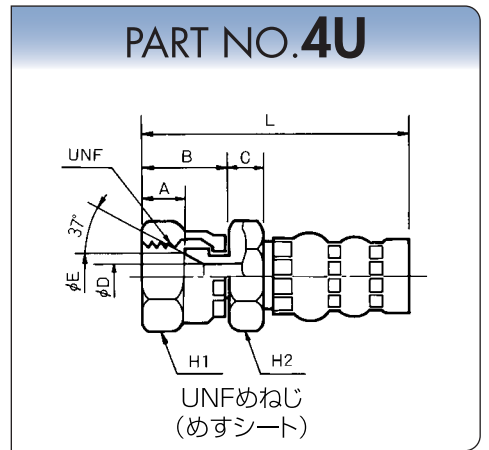

SIB210

サイズ	A	D	E	F	H	J	G (PF)	L	重量g
6	8.5	4.2	9.5	34	19	26	1/4	49	51
9	9.5	6.5	13.0	47	22	34	3/8	60	90
12	10.5	9.5	16.0	54	27	39	1/2	70	129
15	12.5	12.6	22.0	70	36	50	3/4	85	380
19	12.5	16.0	22.0	70	36	50	3/4	87	415
25	12.5	21.0	28.0	87	41	68	1	115	710

PART NO.904

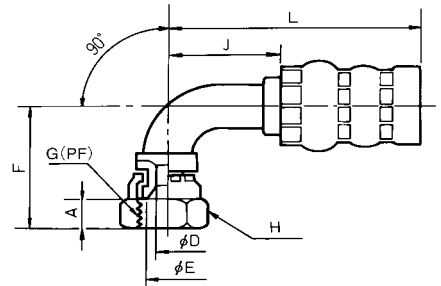

90°ベンドフィッティング
(めすシート)

サイズ	A	D	E	F	H	J	G (PF)	L	重量g
6	4.5	4.2	7.0	31.5	19	26	1/4	49	51
9	5.5	6.5	9.7	40	22	34	3/8	60	90
12	7.0	9.5	13.0	55	27	37	1/2	68	129
15	9.0	12.6	19.0	70	36	50	3/4	85	380
19	9.0	16.0	19.0	70	36	50	3/4	87	415
25	9.5	21.0	24.0	87	41	68	1	115	710

PART NO.905

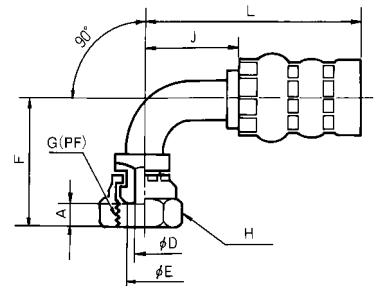

90°ベンドフィッティング
(おすシート)

サイズ	A	D	E	F	H	J	G (PF)	L	重量g
6	8.5	4.2	9.5	24	19	44	1/4	67	46
9	9.5	6.5	13.0	26	22	49.5	3/8	76	83
12	10.5	9.5	16.0	29.6	27	55.5	1/2	86	125
15	12.5	12.6	22.0	38	36	70	3/4	105	340
19	12.5	16.0	22.0	38	36	70	3/4	107	375
25	12.5	21.0	28.0	46.4	41	84.5	1	132	620

PART NO.454

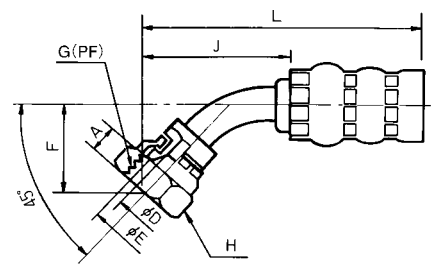

45°ベンドフィッティング
(めすシート)

サイズ	A	D	E	F	H	J	G (PF)	L	重量g
6	4.5	4.2	7.0	16.5	19	34.5	1/4	58	46
9	5.5	6.5	9.7	20.9	22	44.5	3/8	71	83
12	7.0	9.5	13.0	31.2	27	55.5	1/2	86	125
15	9.0	12.6	19.0	38	36	70	3/4	105	340
19	9.0	16.0	19.0	38	36	70	3/4	107	375
25	9.5	21.0	24.0	46.4	41	84.5	1	132	620

PART NO.455

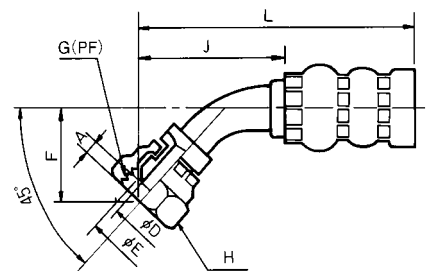

45°ベンドフィッティング
(おすシート)

SIBシリーズ

SIB210

サイズ	B	C	D	F	H	J	R(PT)	L	使用 Oリング	重量g
6	14	6	4.2	39	17	23	1/4	46	P-6	42
9	14	6	6.5	45	19	34	3/8	60	P-9	73
12	18	8	9.5	58	22	47	1/2	78	P-12	123

サイズ	B	C	D	F	H	J	G(PF)	L	使用Oリング		重量g
									1	2	
6	10.5	8	4.2	37.5	19	23	1/4	46	P-6	P-11	46
9	10.7	8	6.5	43.5	22	34	3/8	60	P-9	P-14	76
12	14.5	10	9.5	57	27	47	1/2	78	P-12	P-18	134

サイズ	B	C	D	F	H	J	R(PT)	L	使用 Oリング	重量g
6	14	6	4.2	22.6	17	38.6	1/4	62	P-6	39
9	14	6	6.5	24.3	19	47.8	3/8	74	P-9	68
12	18	8	9.5	30.7	22	63.1	1/2	94	P-12	115

サイズ	B	C	D	F	H	J	G(PF)	L	使用Oリング		重量g
									1	2	
6	10.5	8	4.2	21.6	19	37.6	1/4	61	P-6	P-11	43
9	10.7	8	6.5	23.3	22	46.8	3/8	73	P-9	P-14	73
12	14.5	10	9.5	29.6	27	62	1/2	93	P-12	P-18	126

PART NO. SW901

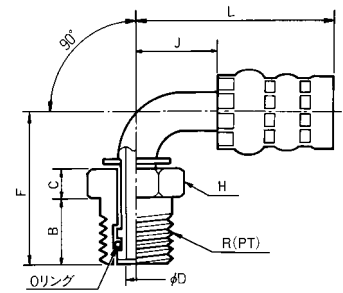

90°バンドフィッティング
(おねじ簡易スイベルタイプ)

PART NO. SW902

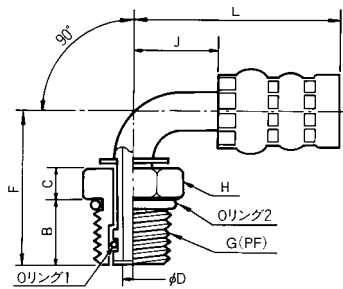

90°バンドフィッティング
(平行ねじ簡易スイベルタイプ)

PART NO. SW451

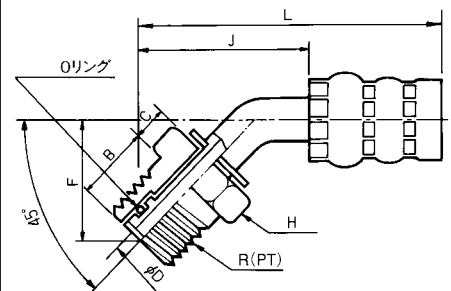

45°バンドフィッティング
(おねじ簡易スイベルタイプ)

PART NO. SW452

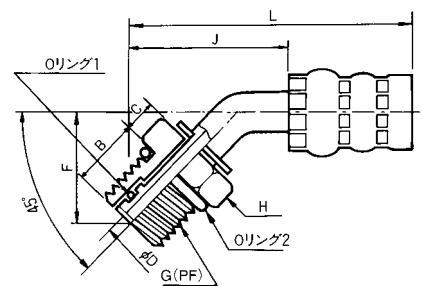

45°バンドフィッティング
(平行ねじ簡易スイベルタイプ)

